

Varenummer: 20167B482SW  
Beskrivelse: E+G  
Bred fod holder GN167-B48-2-SW

## Mål

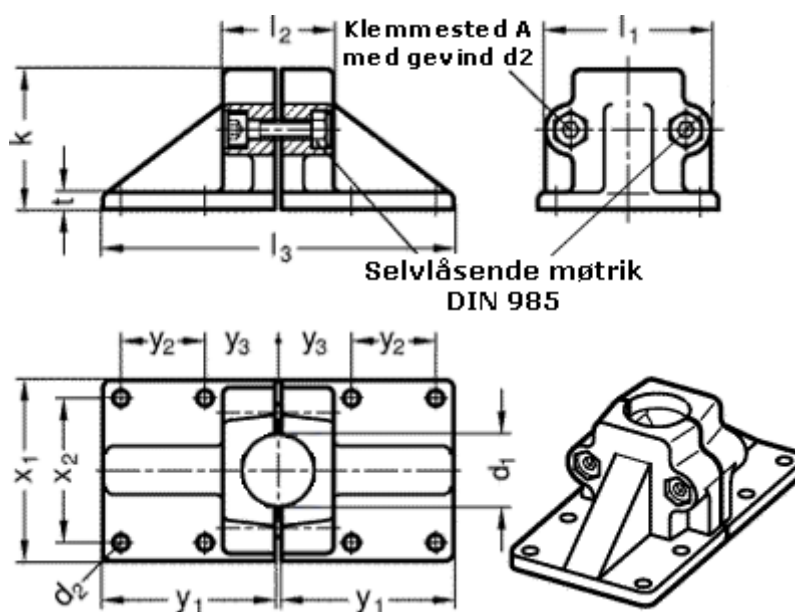

$d_1 = B48$	$x_1 = 115$
$d_2 = 11$	$x_2 = 90$
$d_3 = M10$	$y_1 = 108$
$k = 91$	$y_2 = 50$
$l_1 = 98$	$y_3 = 45$
$l_2 = 70$	
$l_3 = 218$	
$t = 14$	